



Republic Regenerative Blower HRB 401

REPUBLIC

Blower Systems®

Republic offers a complete line of regenerative blowers for high vacuum or compressed air applications in both horizontal and vertical mounted positions. TEFC motors are CE certified. The impeller is directly connected to the motor shaft, providing powerful air force without undue friction. The bearings are outside the compression chamber, ensuring maximum operational reliability under high differential pressure. This low-maintenance, oil-free design provides continuous, dependable service to our customers.

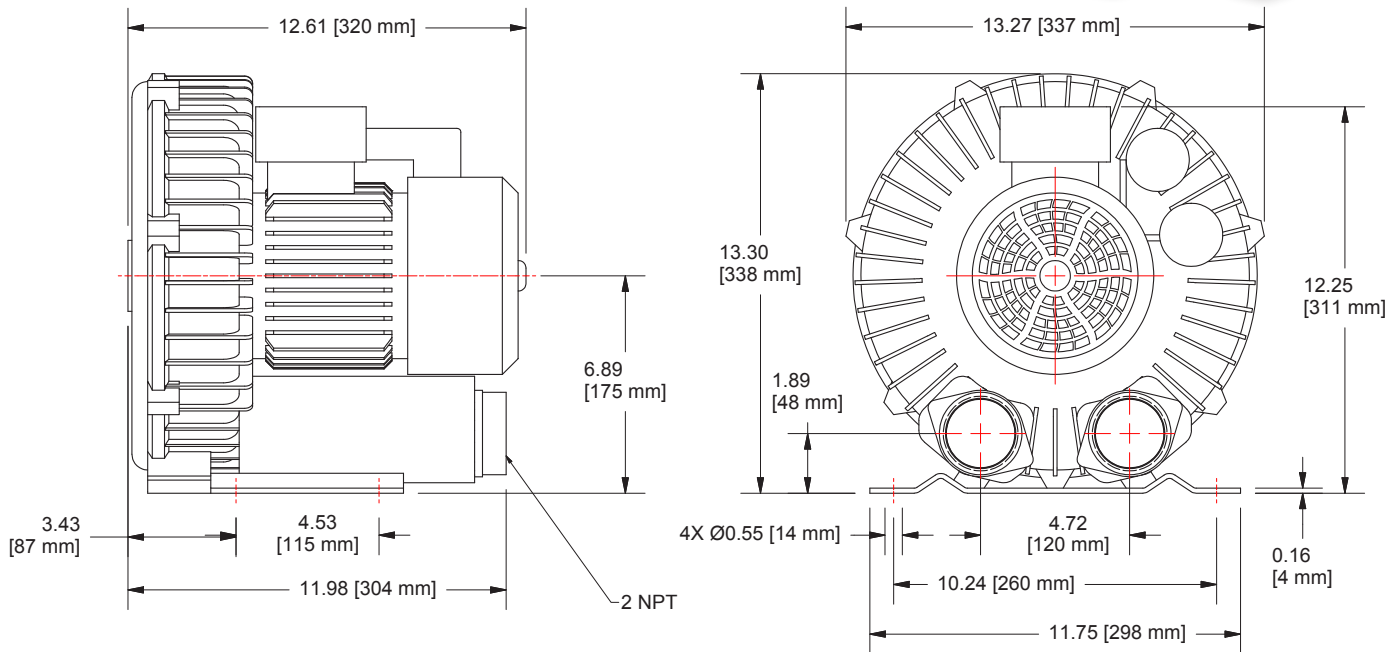
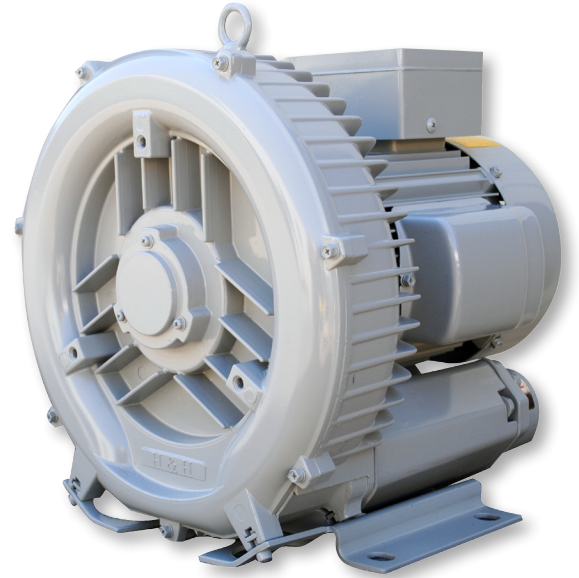

Advantages

- ▲ Low noise 75dB
- ▲ Continuous, low-maintenance operation
- ▲ Saves space and electricity
- ▲ Trouble-free installation
- ▲ Easy replacement of parts
- ▲ Outboard bearings yielding longer life
- ▲ Dual voltage 110/220

Product Options

- ▲ 2" Relief Valve (recommended)
 - ▲ Inlet Filter (recommended)
 - ▲ Liquid filled gauge
 - ▲ Check Valve
 - ▲ Belt-driven bare shaft blowers are available
 - ▲ Explosion proof motors available
- (Class 2/Groups E,F,G/Division 1 Certified)

Phase	Motor (HP)	Current @110 V	Current @220 V	Sounds Level (dB)	Rated Pressure (in. H ₂ O)		Rated Vacuum (in. H ₂ O)		Air Flow (cfm)		Weight (lbs)
					60 Hz	50 Hz	60 Hz	50 Hz	60 Hz	50 Hz	
1	3.0	30.0	15.0	75	110	87	79	71	141	113	78

5131 Cash Road ▲ Dallas, TX 75247 ▲ P 214.631.8070 ▲ F 214.631.3673 ▲ 800.847.0380

www.republicsales.com



Republic Regenerative Blower HRB 401

REPUBLIC
Blower Systems®

Pressure vs. CFM

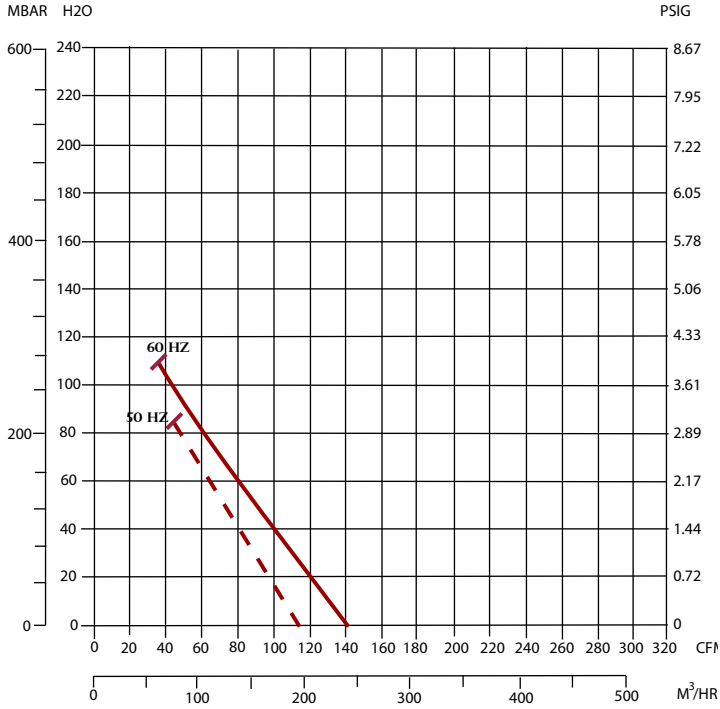

Vacuum vs. CFM

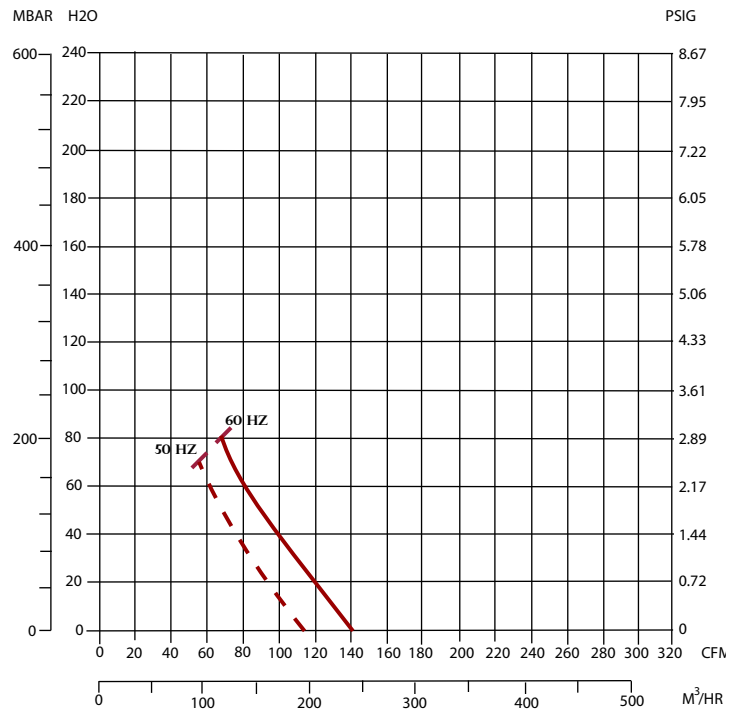

All Republic Regenerative Blowers are available in preassembled kits for either pressure or vacuum applications. These kits include an inlet filter and relief valve, and have been tested prior to shipment. Optional items for these kits include check valve and gauge.

KPHRB401 - Pressure Kit Drawing

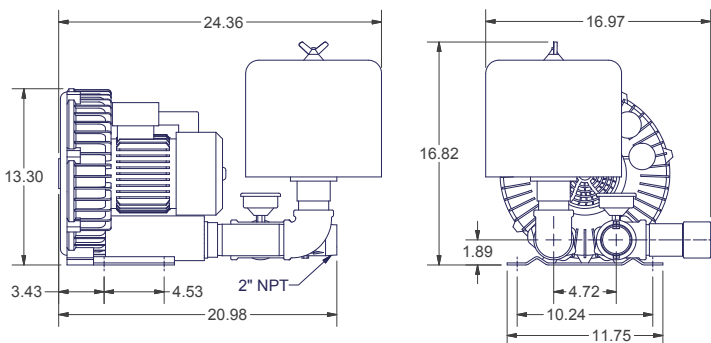

KVHRB401 - Vacuum Kit Drawing

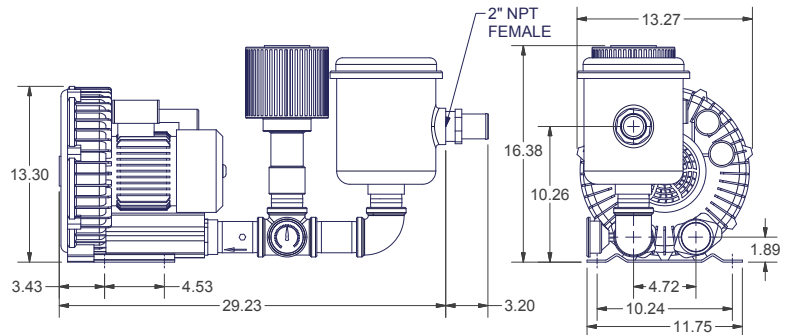

5131 Cash Road ▲ Dallas, TX 75247 ▲ P 214.631.8070 ▲ F 214.631.3673 ▲ 800.847.0380

www.republicsales.com

©Republic Blower Systems®
Modified 10.2012